



## Installation Manual

---

### R5 Pitched Roof Mounting System

Portrait Orientation

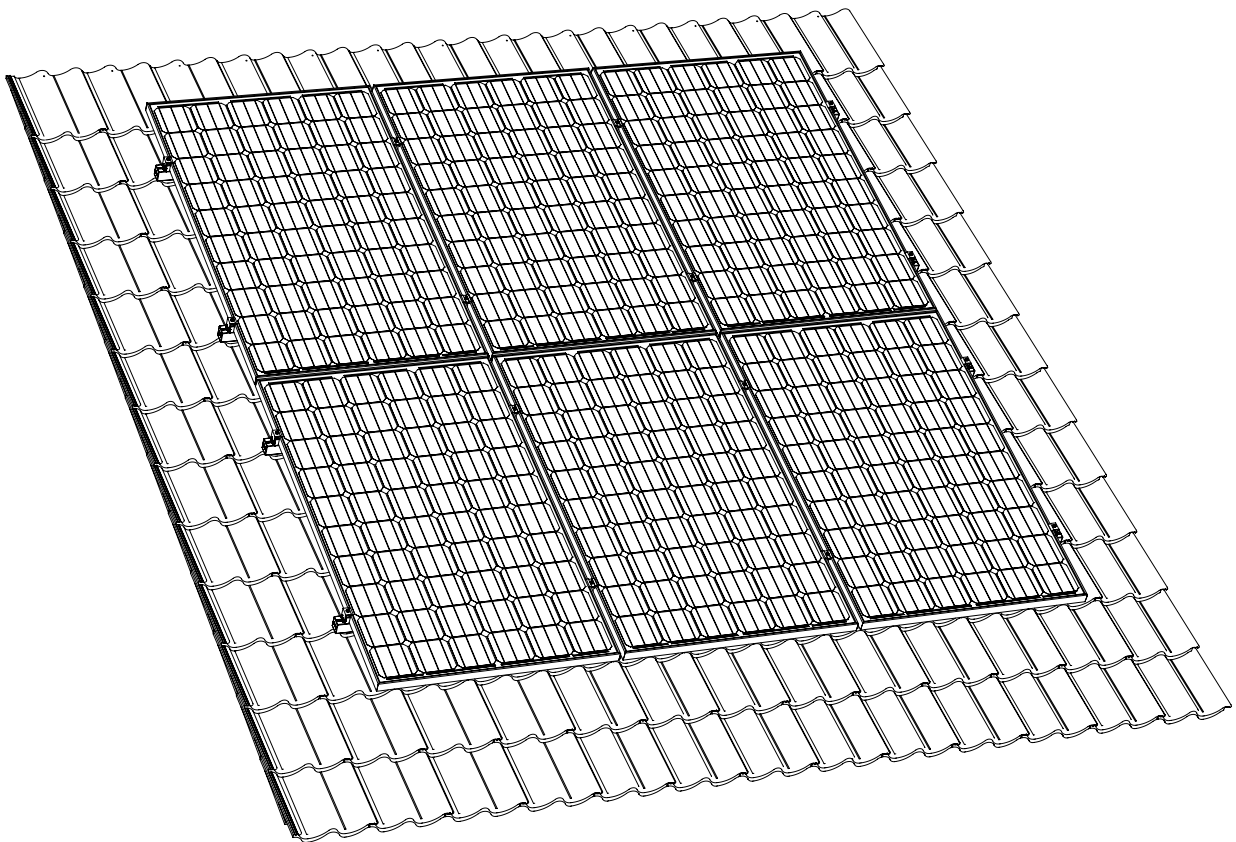



## **Contact Information**

Autarco Group B.V.  
Schansoord 60  
5469 DT Erp  
The Netherlands

[www.autarco.com](http://www.autarco.com)  
[info@autarco.com](mailto:info@autarco.com)

## **Other Information**

This manual is an integral part of the unit. Please read the manual carefully before installation, operation or maintenance. Keep this manual for future reference.

Product information is subject to change without notice. All trademarks are recognized as the property of their respective owners.

© Autarco Group B.V.  
All rights reserved.

## Table of Contents

<b>1.</b>	<b>Introduction</b> .....	<b>5</b>
1.1	Safety Symbols.....	5
1.2	Target Audience.....	5
1.3	Mounting Hook Models Covered.....	5
<b>2.</b>	<b>Preparing for Installation</b> .....	<b>6</b>
2.1	Safety Instructions.....	6
2.2	Package Contents.....	7
2.3	Tools & Materials Required.....	8
2.4	Solar Panel Position Guideline.....	9
2.5	Hooks and Rails Position Guideline.....	10
<b>3.</b>	<b>Installation</b> .....	<b>11</b>
3.1	Marking the position of mounting hooks.....	12
3.2	Mounting hooks onto the roof.....	13
3.3	Attaching rails onto the hooks.....	14
3.4	Clamping modules onto the rails.....	15
3.4.1	How to assemble clamps onto the rails.....	15
3.4.2	Installing first module onto the rails with end clamps.....	16
3.4.3	Installing modules onto the rails with middle clamps.....	17
3.4.4	Securing final module with end clamps.....	18
3.5	Installation complete.....	19
<b>4.</b>	<b>Disposal</b> .....	<b>19</b>

# 1. Introduction

The main purpose of this installation manual is to provide instructions and detailed procedures for installing and maintaining Autarco pitched roof mounting system based on R5 type rails on buildings up to 20m in height.

## 1.1 Safety Symbols



**DANGER!** A danger symbol indicates a hazardous situation, which if not avoided, will result in death or serious injury.



**WARNING!** Indicates a hazardous situation which, if not avoided, can result in serious injury.



**ATTENTION!** Attention statements are used to indicate where a part of the process or equipment has a special requirement. Attention statements should be followed at all times.

## 1.2 Target Audience

This manual is intended for qualified personnel who installs an Autarco solar PV solution with R5 pitched roof mounting systems. Before any further action, the installer must first read all safety regulations and be aware of the potential danger to operate high-voltage devices such as PV modules.



**ATTENTION!** Qualified personnel means a person with valid license from the local authority for:

- Installing electrical equipment and PV power systems (up to 1000 V)
- Applying all applicable installation codes and using personal protective equipment (PPE)
- Analyzing and reducing the hazards involved in performing electrical work

## 1.3 Mounting Hook Models Covered

The R5 rail is installed on a pitched roof using one of the following Autarco pitched roof mounting hooks:

- M2.THX1
- M2.TH1, M2.TH2, M2.TH5, M2.TH6
- M2.HB10L, M2.HB12L

Further information on the types of roof mounting hooks are available online at [www.autarco.com/downloads/](http://www.autarco.com/downloads/)

## 2. Preparing for Installation

### 2.1 Safety Instructions



DANGER! Do not install during severe or sub-zero weather conditions.



WARNING! Never step or sit on the glass surface of a solar module. The glass may break, resulting in shock or bodily injury. The module may also stop generating power.



WARNING! Always use the supplied parts to attach the solar modules and mounts. Use of other parts is dangerous and may cause the solar modules or mounts to loosen or fall.



DANGER! Do not install this system on a roof with pitch > 60 degrees.



WARNING! The installation, maintenance, recycling and disposal of the mounting components must be performed by qualified personnel in compliance with national and local standards and regulations.



WARNING! Always install modules onto a minimum of two rails which are parallel to the shorter side of the module. Otherwise, loosening of the modules may occur due to expansion or contraction of the rails under varying heat.

Any unauthorized actions including modification of product functionality of any form will affect the validation of warranty service; Autarco may deny the obligation of warranty service accordingly.

## 2.2 Package Contents

① Solar Modules  
S1.MC/MCE/MD/MDE/PC/PCE

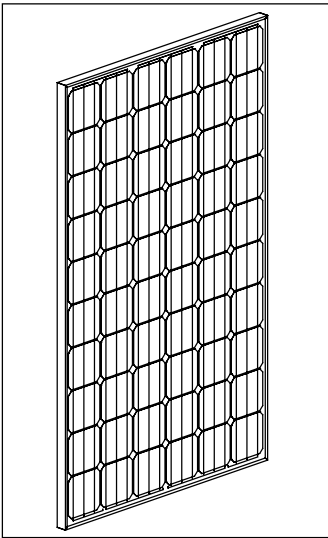

② R5 Rail  
M1.R5L3150/R5(B)L4200

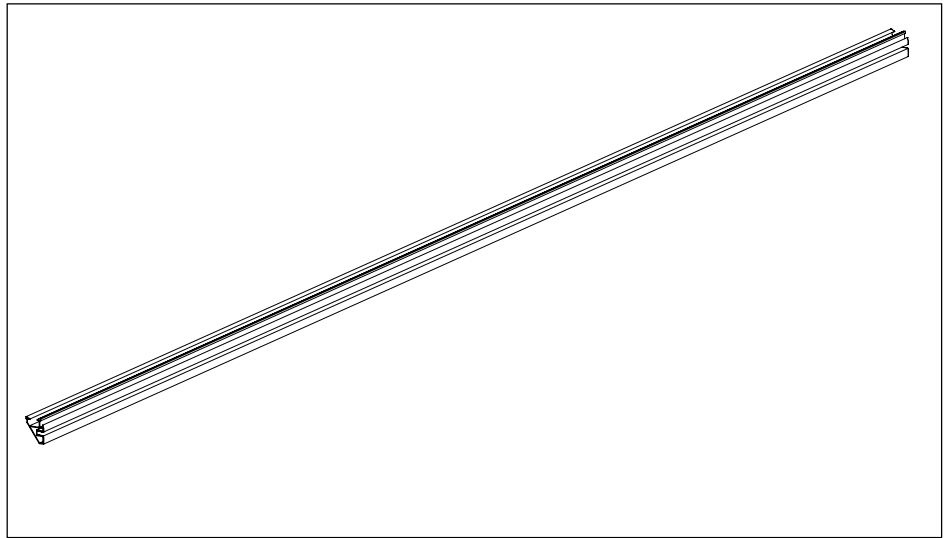

③ Splice Connector  
M1.R5SC

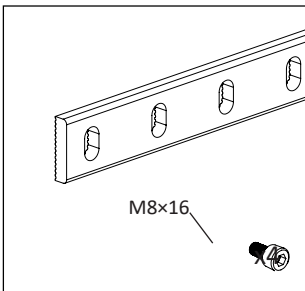

④ End Cap  
M1.R5CAP

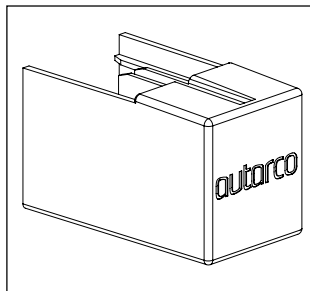

⑤ End Clamp  
M1.R5(B)EC

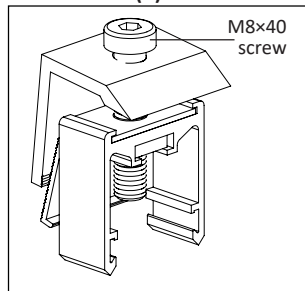

⑥ Middle Clamp  
M1.R5(B)MC

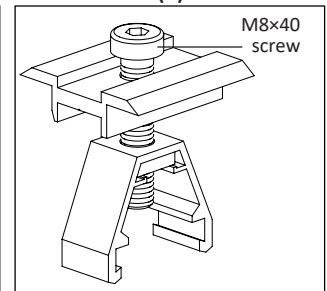

In this manual, we use the THX1 Mounting Hook (7a) which can also be converted into the 'screwed' (7b) variation.

⑦a THX1 Mounting Hook  
M2.THX1

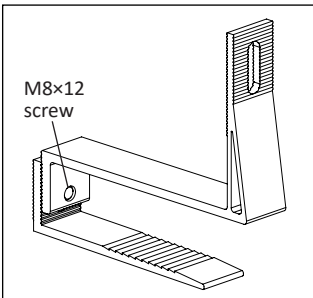

⑦b THX1 Screwed Mounting Hook  
M2.THX1

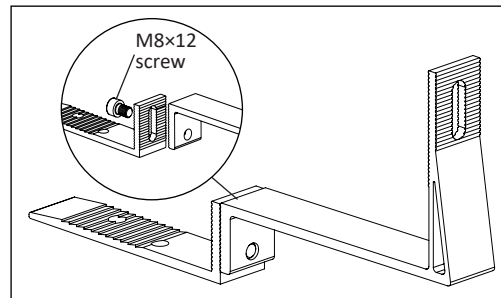

OR

⑧ M8x16 nut

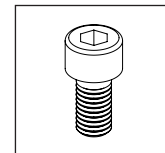

Please note the component numberings as they will be referenced in the installation section.

## 2.3 Tools & Materials Required

- Ⓐ Wood Mounting Screw (maximum major diameter, 8.5mm)  
*e.g. Self-Tapping Screw ST6,3x19*

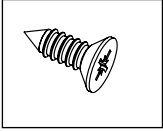

- Ⓑ Tape Measure

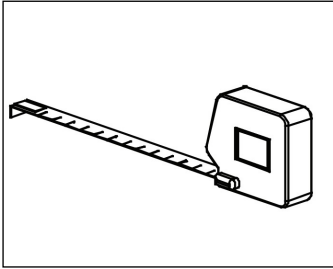

- Ⓒ Marker or Chalk

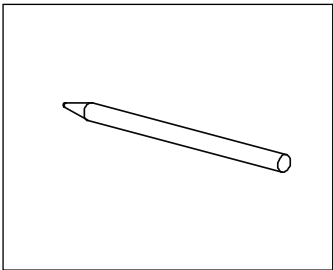

- Ⓓ1 Ratchet

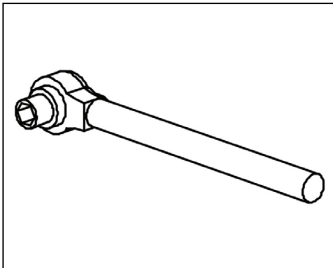

- Ⓓ2 Electric Screw Driver

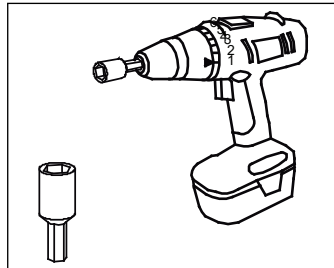

OR

- Ⓔ Saw



## 2.4 Solar Panel Position Guideline



ATTENTION! DO NOT install this system on a roof with pitch > 60 degrees.

The minimum clearance of solar panels from the roof edges, gutters and ridges is typically 30cm (please check with your local building regulations).

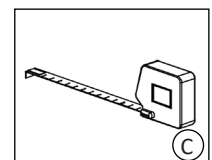
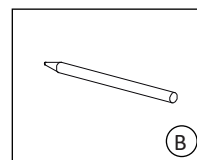
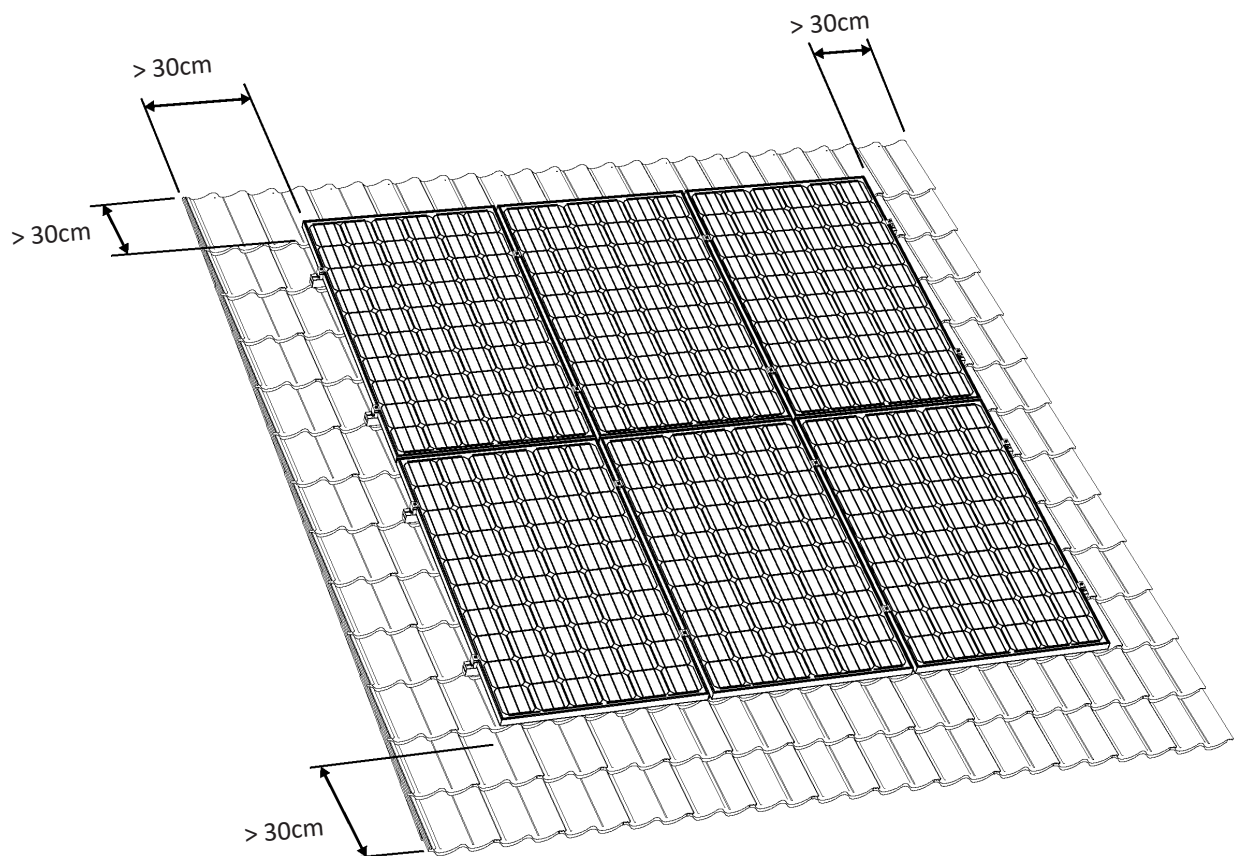

## 2.5 Hooks and Rails Position Guideline

Before proceeding with the installation, make sure the hooks and rails are installed according to the dimensions given below:

- The maximum distance between two successive hooks **(H1)** is 120cm, but typically 60-80cm.  
*Refer to our calculator for specific value*
- The distance between rails **(R2)** is between 0.5 and 0.7 times the length of the module **(L)**.  
*refer to the 'Mounting' section of your modules manual for module-specific values*
- The maximum rail overhang distance **(OH3)** is 30cm.

The values for Hook Distance **(H1)** and Overhang Distance **(OH3)** are determined by wind zone, height of the building and terrain code.

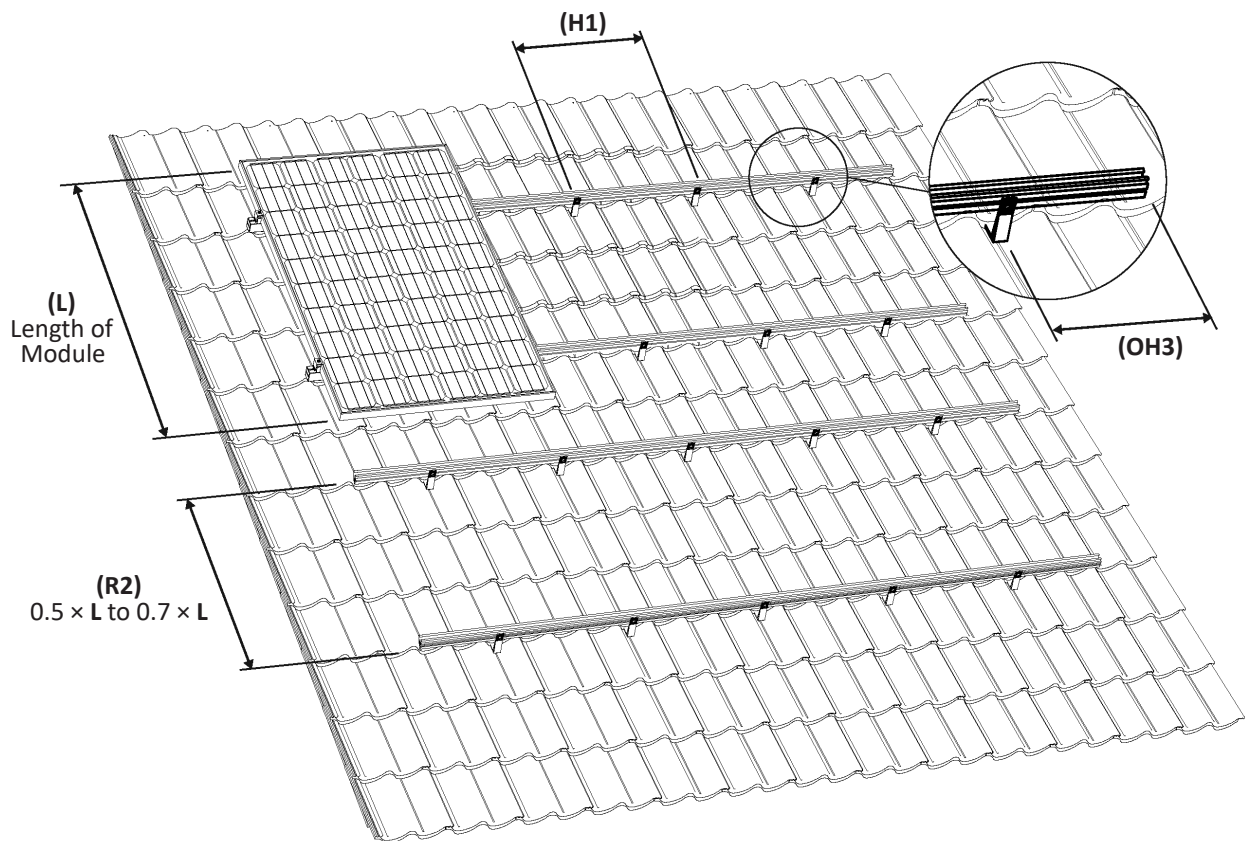

### 3. Installation

Exploded view of the R5 Mounting System. See pages 7 and 8 for component numberings.

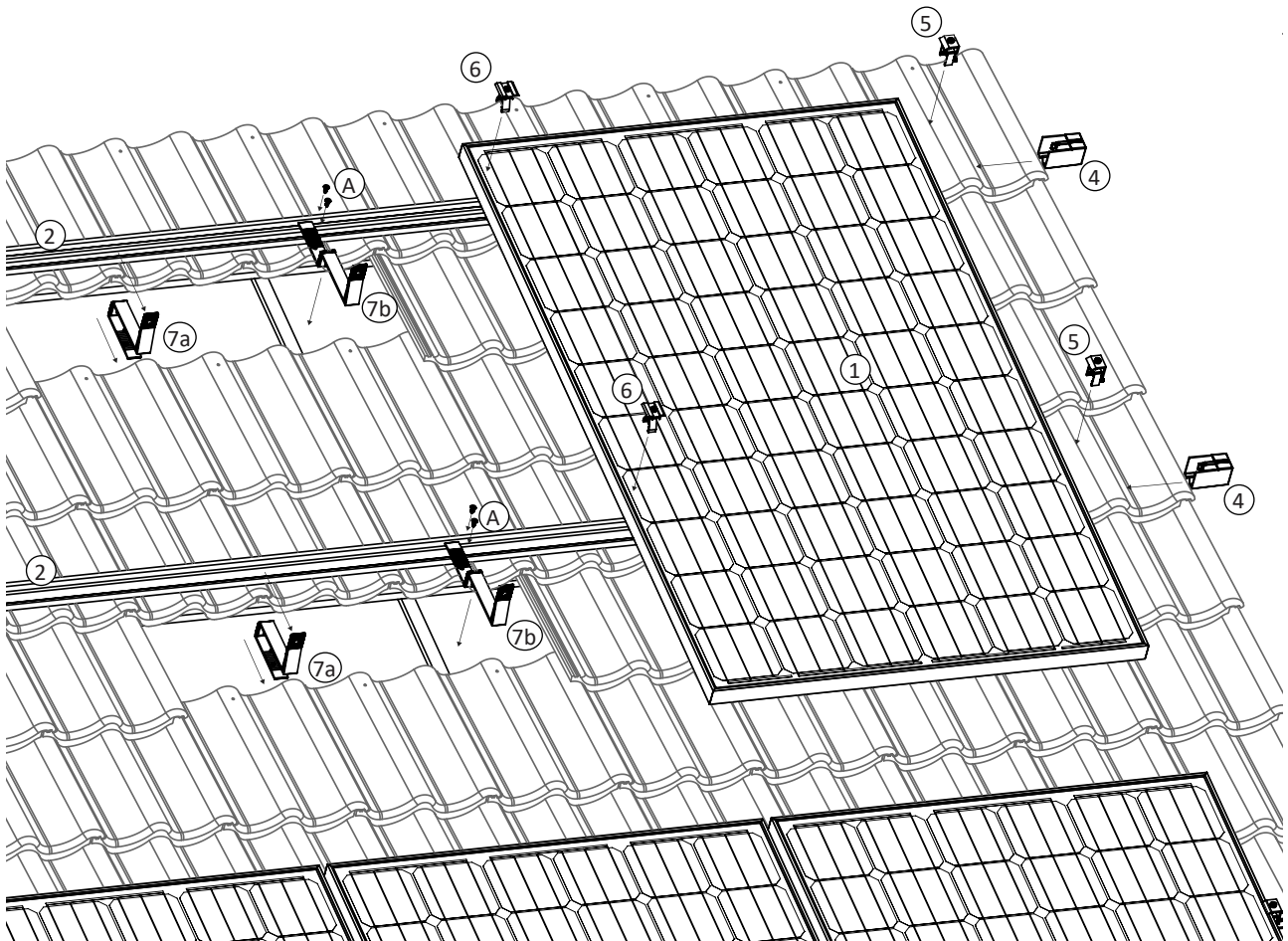

An overview of the installation steps for the R5 Mounting System in exact order:

- 3.1 Marking the position of mounting hooks
- 3.2 Mounting hooks onto the roof
- 3.3 Attaching rails onto the hooks
- 3.4 Clamping modules onto the rails
- 3.5 Installation complete

## 3.1 Marking the position of mounting hooks

**Step 1** – Measure and identify the position of the mounting hooks using a measuring tool (C).  
*see section 2.5 (pg 10) for the recommended hook (H1) and rail (R2) distances*

**Step 2** – Use a chalk or marker pen (B) to mark the roof tile that will be removed for mounting. This is the tile directly above the tile that the hook mounts onto.

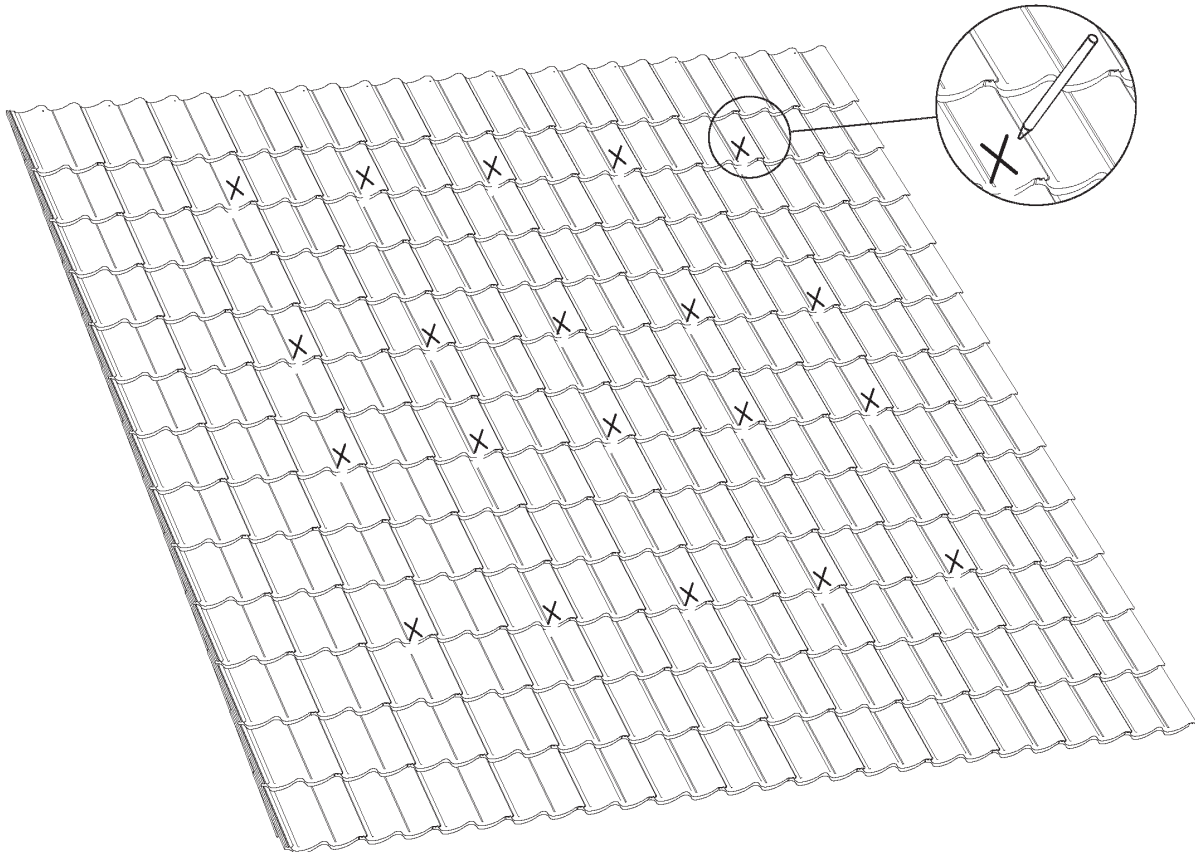

## 3.2 Mounting hooks onto the roof

We offer various types of roof hooks depending on rafter, batten and tile specifications. In this manual we illustrate the installation procedure for the **THX1 Hook (7a)** and **THX1 Screwed Hook (7b)**.

**Step 1** – Remove the roof tiles marked in 3.1, by sliding it upwards and under the roof tile immediately above it.

For **THX1 Hook (7a)**

**Step 2a** – Fit the THX1 Hook (7a) onto the trough of the roof tile (downward curve of the tile). The hook should secure both the roof tile and the batten.

**Step 3a** – Slide the removed roof tile back in place.

For **THX1 Screwed Hook (7b)**

**Step 2b** – Place the THX1 Screwed Hook (7b) onto the rafter, securing the trough of the roof tile (downward curve of the tile) and the batten below the tile.

**Step 3b** – Use two Wood Mounting Screws (A) to mount the THX1 Screwed Hook (7b) onto the rafter.

**Step 4b** – Slide the removed roof tile back in place.

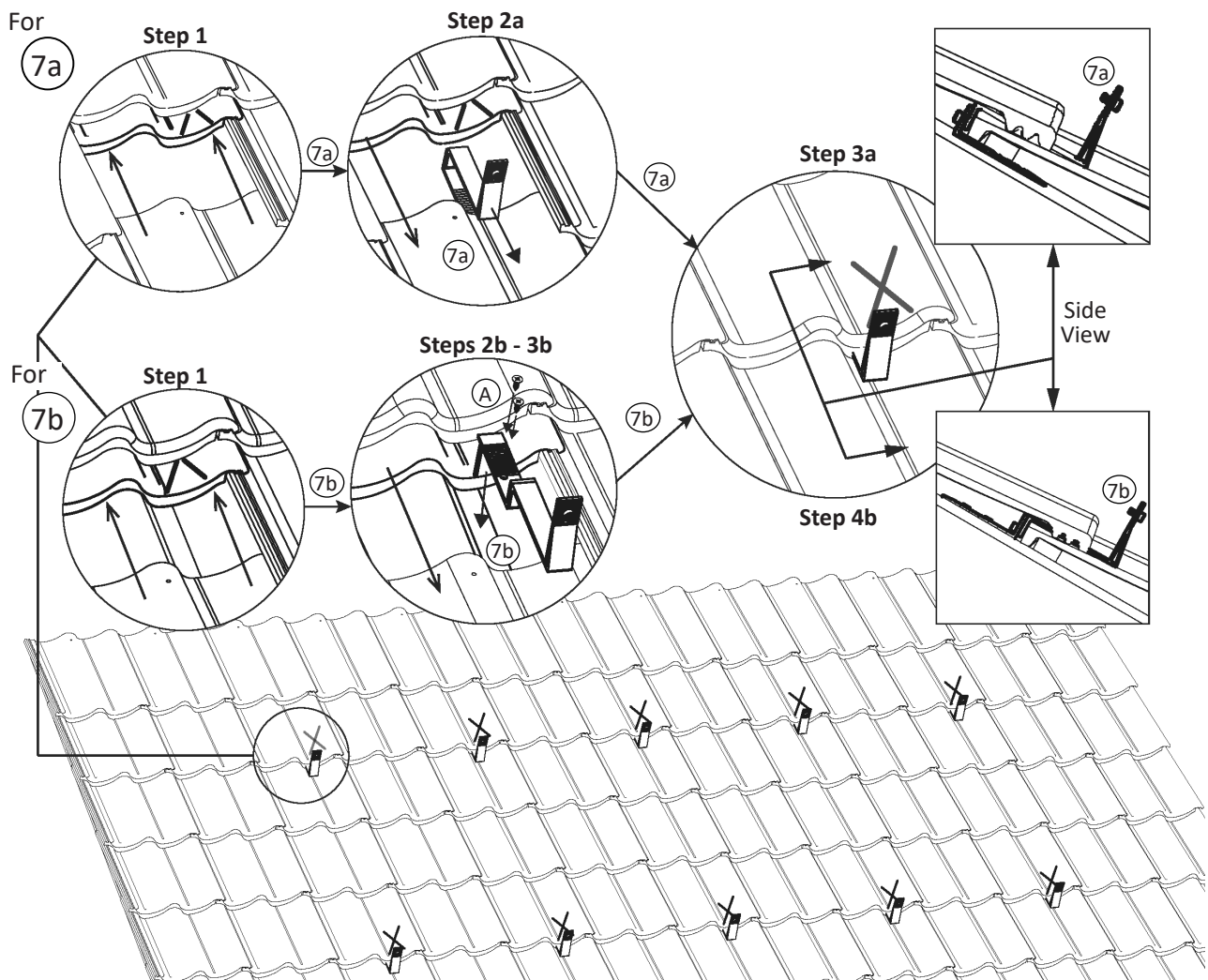



## 3.3 Attaching rails onto the hooks

**Step 1** – *<optional>* Connect two or more R5 rails (2) together using the splice connector (3) and M8×16 screws (8) provided.

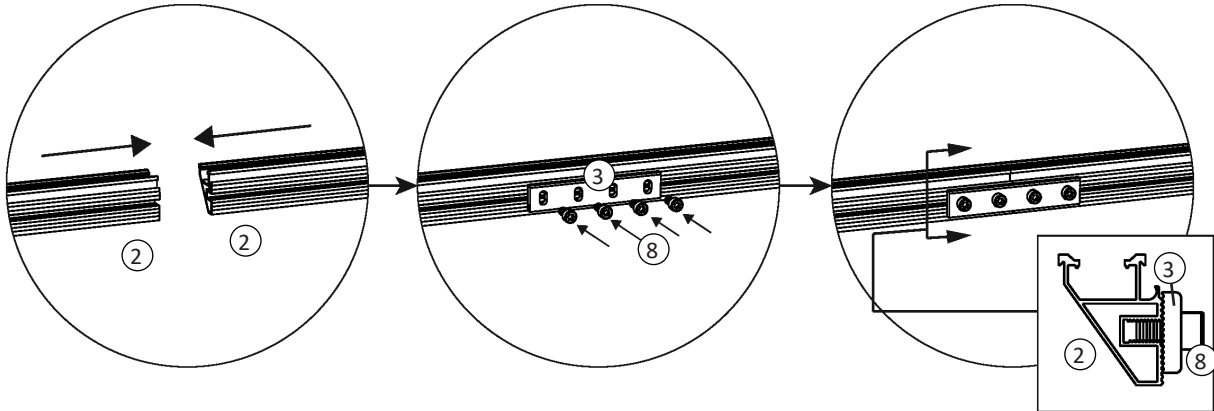

**Step 2** – Attach the R5 rails (2) onto the hooks (7a)/(7b), using the M8×16 screws (8).

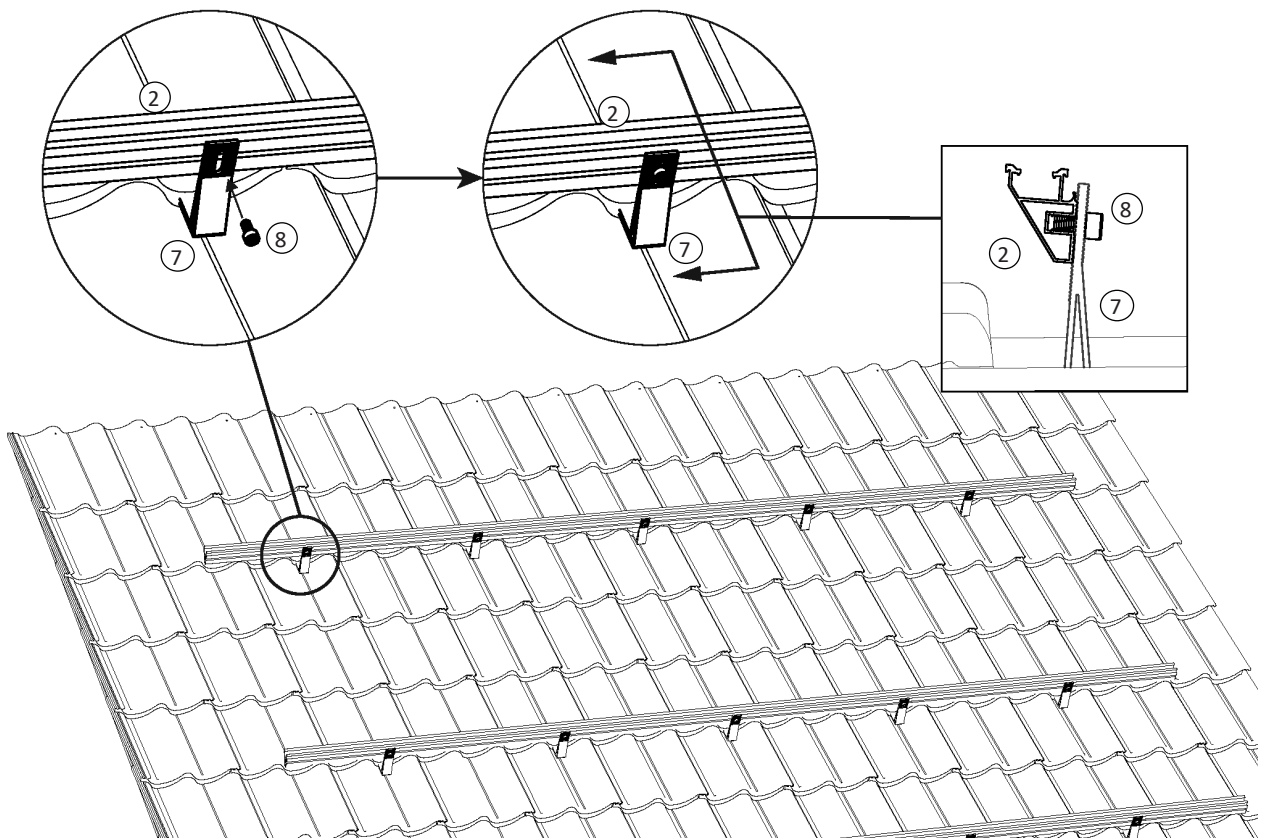

## 3.4 Clamping modules onto the rails

### 3.4.1 How to assemble clamps onto the rails

End clamps ⑤ and middle clamps ⑥ can be easily ‘snapped’ onto the rails using the steps given below. We use the middle clamp ⑥ in this illustration, but the steps are exactly the same for end clamps ⑤.

**Step 1** – Hinge one leg of the clamp onto the rail.

**Step 2** – Bring the other leg onto the rail.

**Step 3** – Press firmly down to snap the unhinged leg in place.

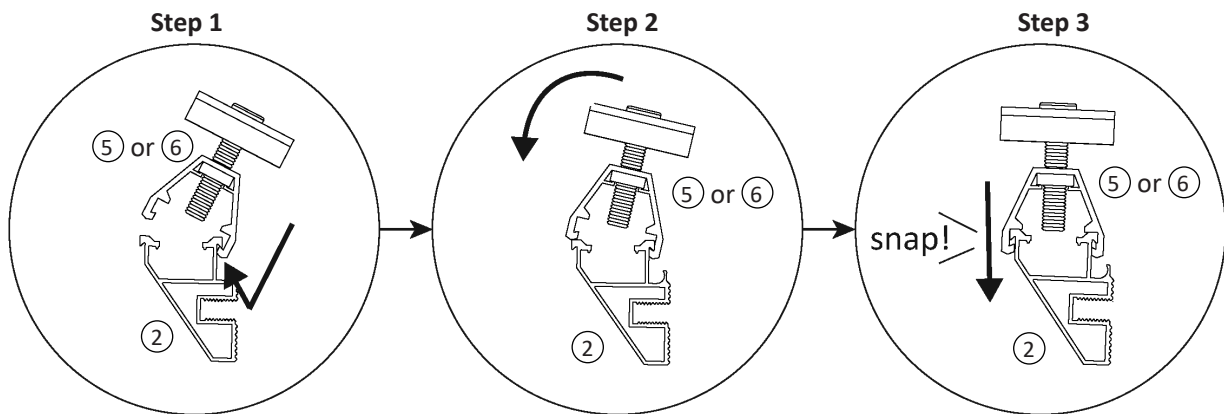

## 3.4.2 Installing first module onto the rails with end clamps

- Step 1** – Assemble the end clamps (5) (see 3.4.1) onto the R5 rails (2). Make sure less than 4cm rail is protruding outwards from the end clamp.
- Step 2** – Position the solar module (1) in portrait on the rails and align against the end clamps (5).
- Step 3** – Tighten the M8x40 screws preassembled on the end clamps (5) to fix the solar module (1) onto the rails.
- Step 4** – Slide the end caps (3) into the the rail to secure the end clamps (5).  
use the wire slot on the rail to tuck away any wires or cables (Fig. 1)

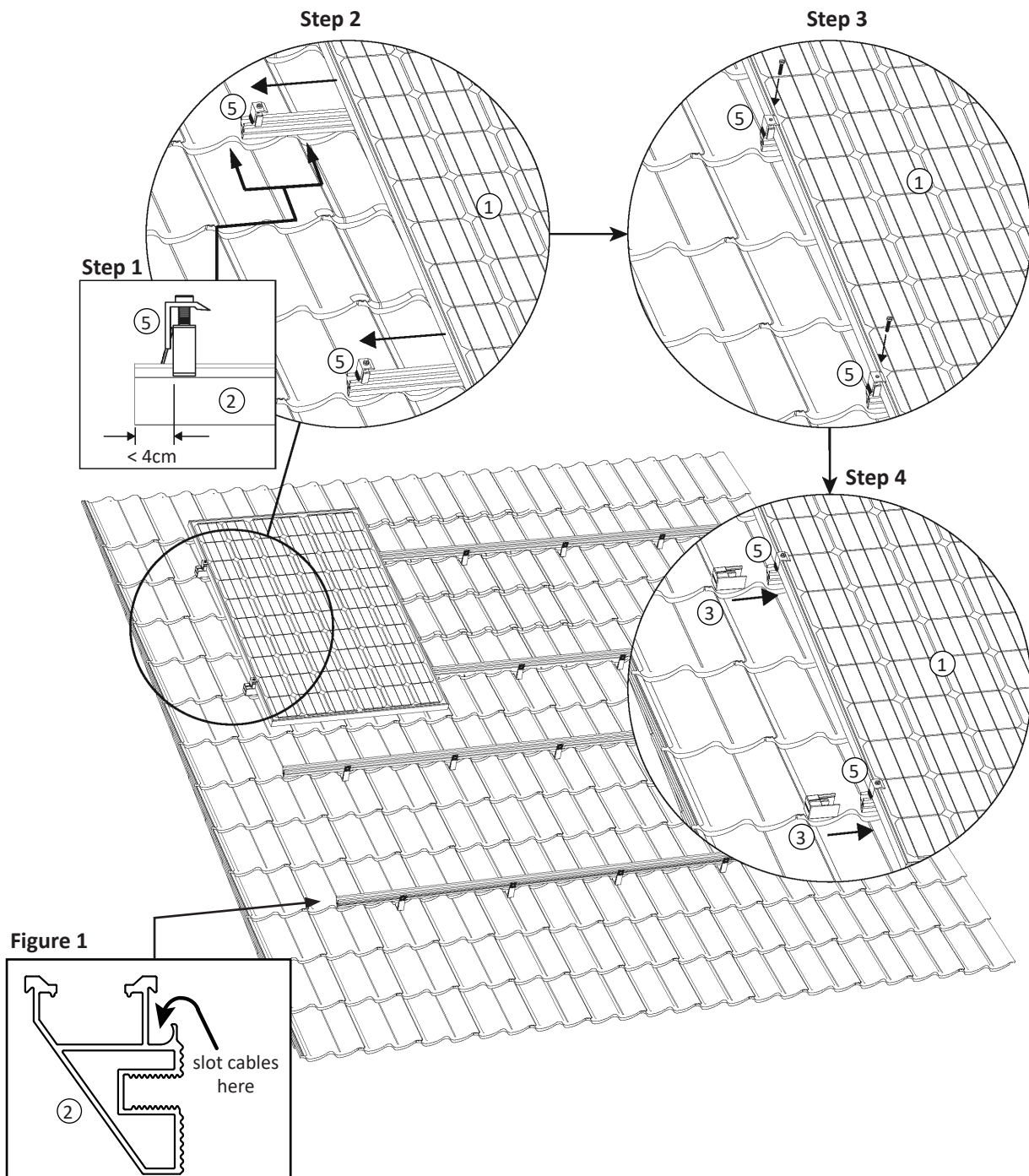



### 3.4.3 Installing modules onto the rails with middle clamps

**Step 1** – Assemble the middle clamps (6) (see 3.4.1) onto the R5 rails and slide the middle clamps left to align with the adjacent module (1). Do not tighten the clamps yet.

**Step 2** – Position the solar module (1) in portrait on the rails and align against the middle clamps (6).

**Step 3** – Tighten the preassembled screws on the middle clamps (6) to fix the solar module (1) onto the rails.

**Step 4** – Repeat steps 1 to 3 until the final solar module along the rails is installed.

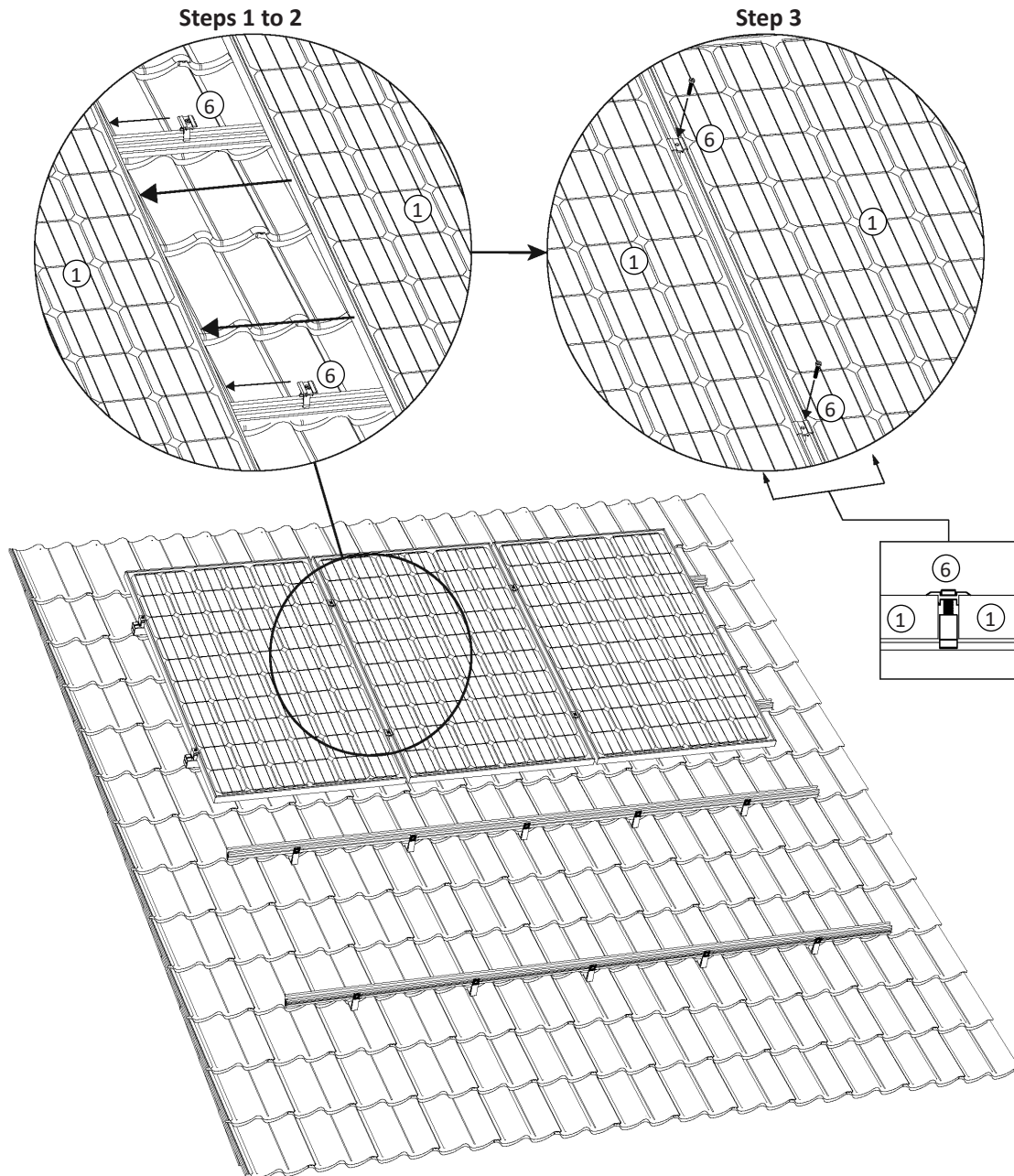

## 3.4.4 Securing final module with end clamps

**Step 1** – Assemble the end clamps (5) (see 3.4.1) onto the R5 rails and slide the end clamps left to align with the final module (1).

**Step 2** – Tighten the M8×40 screws preassembled on the end clamps (5) to fix the solar module (1) onto the rails (2).

**Step 3** – If the rail is protruding outwards more than 4cm from the end clamp, saw off the excess rail.

**Step 4** – Slide the end caps (3) into the the rail to secure the end clamps (5).

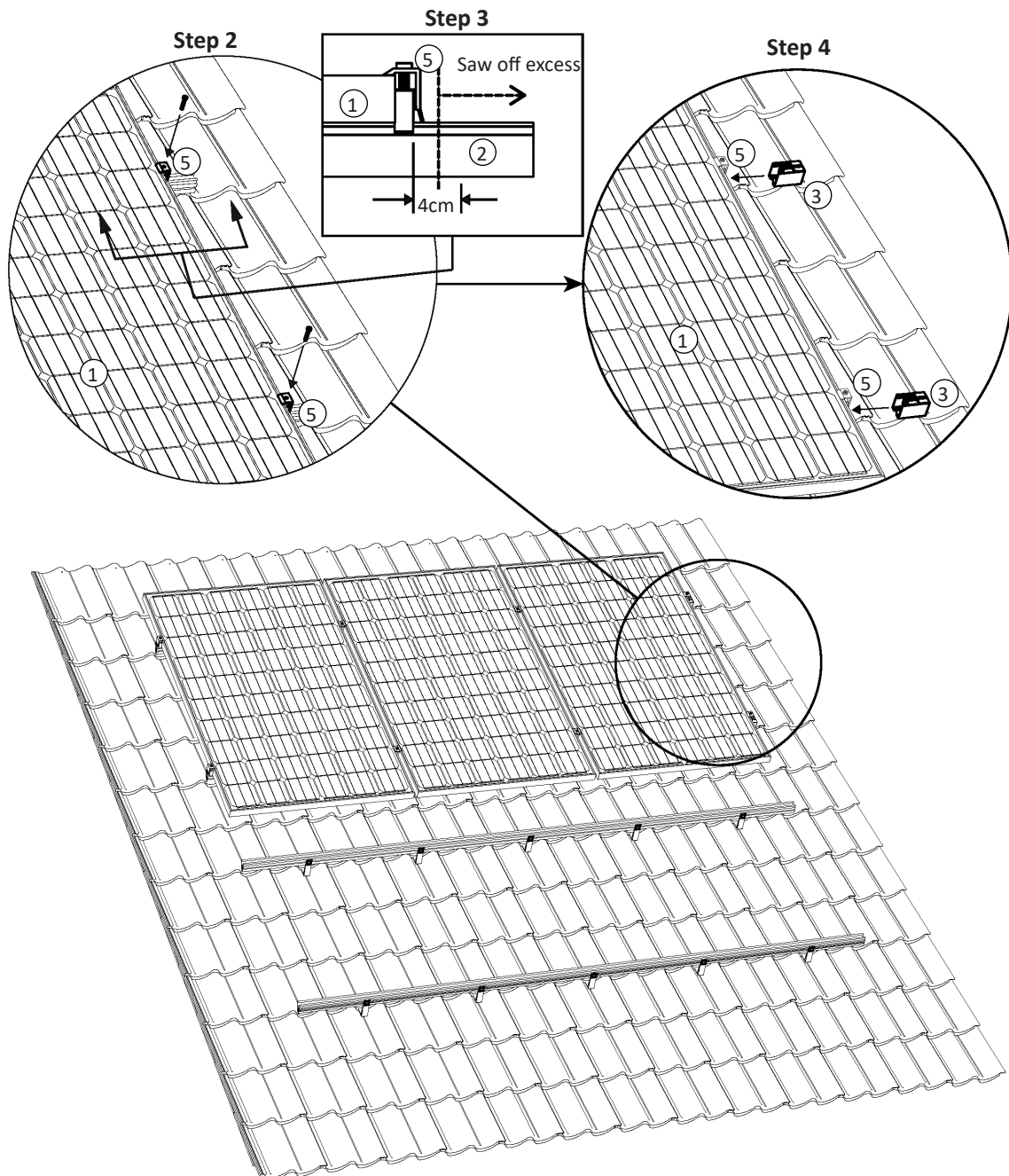

### 3.5 Installation complete

Repeat installation sections 3.4.2 to 3.4.4 to complete remaining rows of rails.

The installation is now complete!

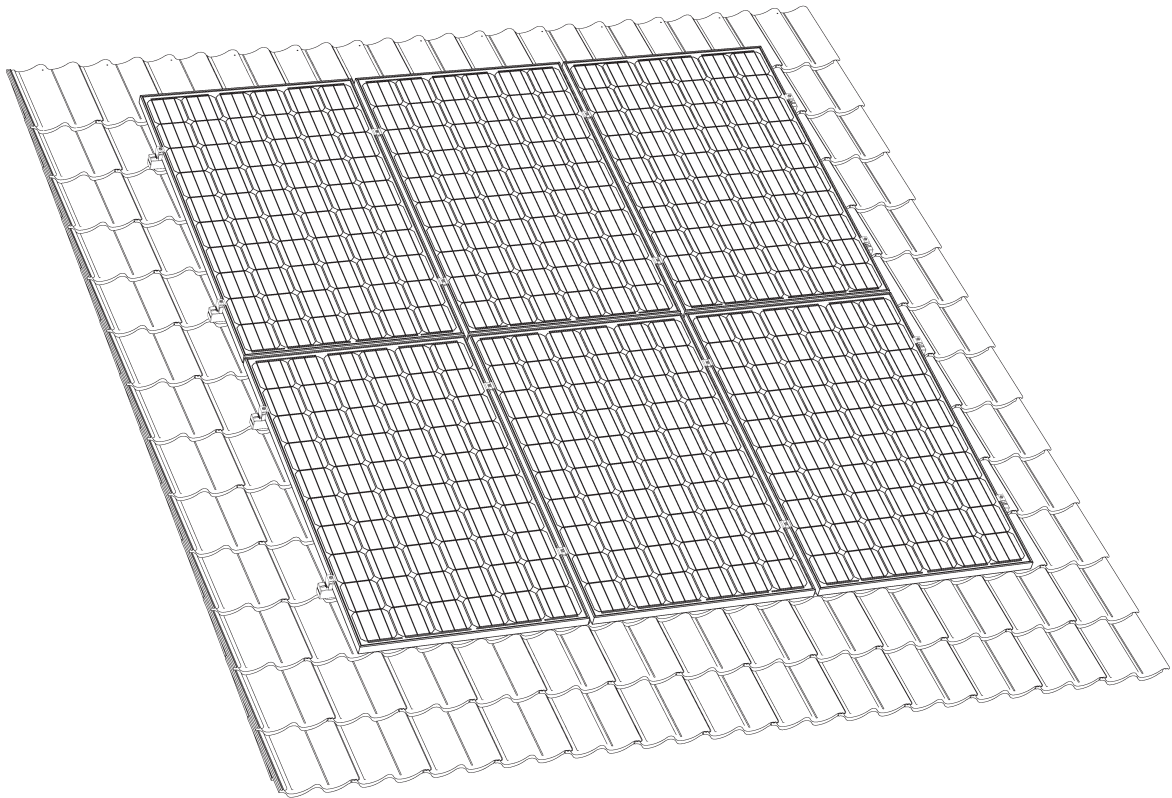

## 4. Disposal

To comply with European Directive 2002/96/EC on waste Electrical and Electronic Equipment and its implementation as national law, electrical equipment that has reached the end of its life must be collected separately and returned to an approved recycling facility. Ignoring this EU Directive may have severe effects on the environment and your health.