

autarco

Installation Manual

Digital LAN-stick for Autarco inverters

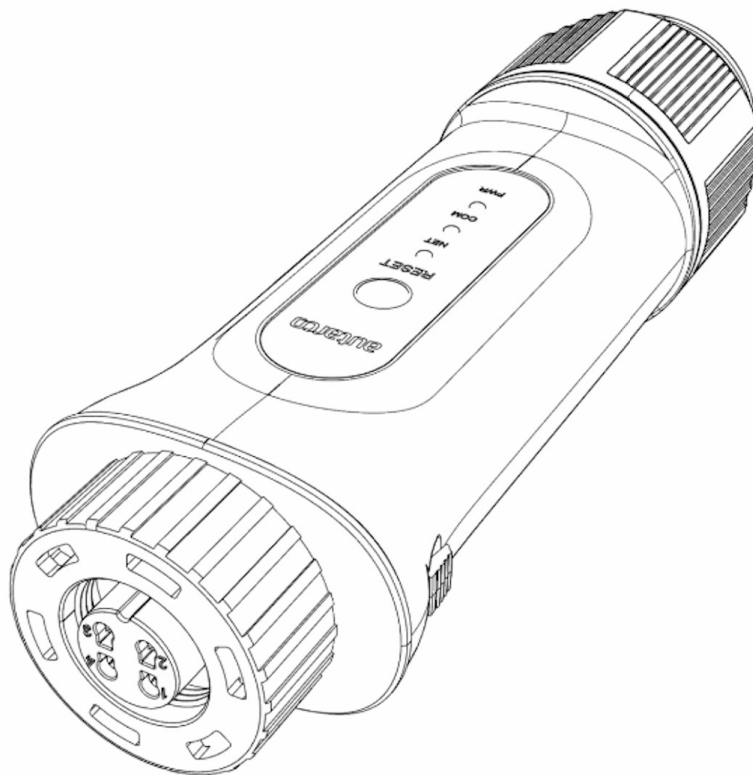

Contact

Autarco Group BV
Torenallee 20
5617 BC Eindhoven
The Netherlands

www.autarco.com
info@autarco.com

Other information

This manual is an integral part of the product. Read the manual carefully before installation, operation or maintenance. Keep this manual for future reference.

Product information is subject to change without notice. All trademarks are recognized as property of their respective owners.

© Autarco Group BV
All rights reserved.

Table of contents

1 Introduction	3
1.1 Read this first	3
1.2 Important symbols	3
2 Connection structure for WiFi monitoring	4
2.1 Topology overview with WiFi monitoring	4
2.2 LED indicator lights	5
3 Installation	6
3.1 Installing stick in inverter	6
3.2 Connection to multiple inverters	7
4 Connecting	9
4.1 Connecting to a wired network	9
4.1.1 Connecting Ethernet cable	9
4.1.2 Set a static IP address	9
4.2 Connecting to a local WiFi network	11
4.2.1 Successful installation check	11
4.2.2 Connecting	11
4.3 New stick's IP address after installation	16
5 Access MyAutarco monitoring platform	17
5.1 Access MyAutarco monitoring platform (installer)	17
5.2 Access MyAutarco monitoring platform (user)	17
6 Resetting the stick	18
7 Troubleshooting	19
7.1 The stick has no power (red 'PWR' light is off)	19
7.2 Red 'PWR' light on, orange 'COM' light is off	19
7.3 Signal quality	20
7.4 Local Settings	20

1 Introduction

1.1 Read this first

The main purpose of this user manual is to provide instructions and a detailed description of procedures for installing, operating, maintaining and troubleshooting the Autarco digital LAN-sticks (LAN-stick D) used with Autarco inverters. Always keep this user manual available at all times.

1.2 Important symbols



WARNING! Indicates safety instructions which, if not followed correctly, could result in injury or property damage.

2 Connection structure for WiFi monitoring

2.1 Topology overview with WiFi monitoring

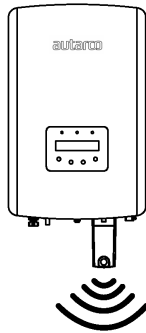

Figure 1. Inverter(s) with LAN-stick (using WiFi)

Inverter(s) communicate via LAN-stick with local router



Picture 2. Local router

LAN-stick communicates via local router with the Autarco server

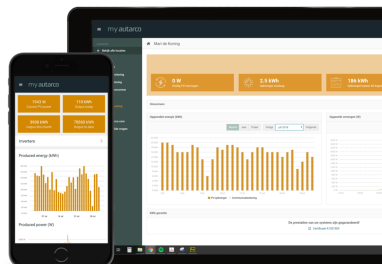

Figure 3. <https://my.autarco.com>

Monitoring data becomes visible in MyAutarco environment

2.2 LED indicator lights

There are three LED indicator lights on the LAN-stick. The PWR-led (red), or *power* light, indicates whether the stick is receiving power. The COM-led (orange), or *communication* light, provides information about the communication between the stick and the inverter. The NET-led (green), or *Network* light, provides information about the communication between the stick and the Autarco server.

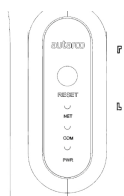

Figure 4. LED Indicators on the Stick



LED Indicator	Status	Description
 NET / Green	ON	The stick is connected to the Autarco server. The monitoring connection was successful. Monitoring data is being sent.
	BLINKING	The stick is trying to connect to the Autarco server.
	OFF	The stick does not connect to the Autarco server.
 COM / orange	ON	The stick can receive data from all connected inverters.
	BLINKING	A. The stick is processing data from an inverter, or, B. The stick is performing a software upgrade (if the green NET light is also flashing at the same time).
	OFF	The stick can <u>not</u> receive data from at least one of the connected inverters.
 PWR / red	ON	The stick has power (the stick is on).
	BLINKING	The stick has insufficient power.
	OFF	The stick does not have power.

Figure 5. Summary of LED information

If the LEDs do not turn on after installation in the inverter, proceed to chapter 6.

3 Installation

3.1 Installing stick in inverter

1. Plug the LAN-stick into the corresponding communication interface of the inverter.

Note: make sure that the position of the connection piece of the stick is correct. Place the small notch on the terminal correctly so that the numbering of the 4-pin connector matches the numbering on the inverter.

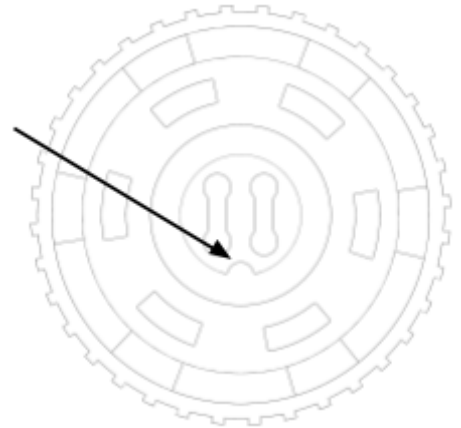

Figure 6. Connector Notch

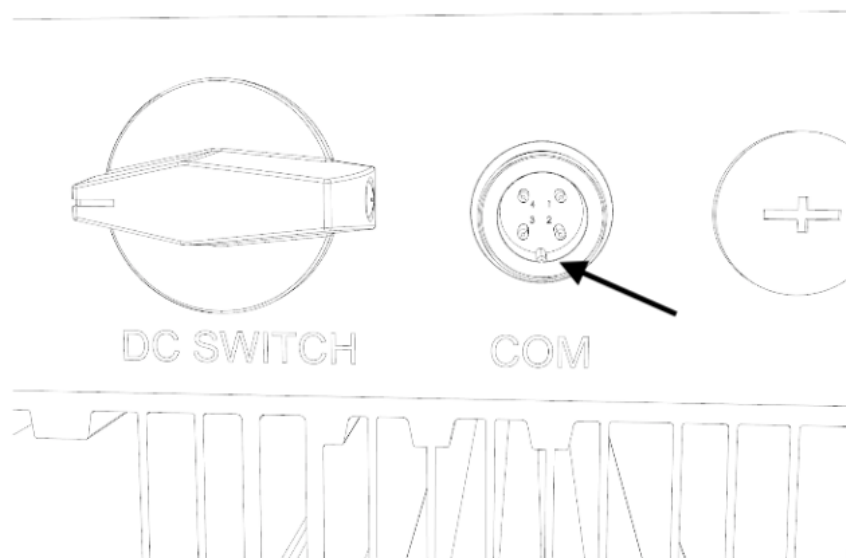

Figure 7. COM port notch

2. Tighten the stick by turning the black ring on the top of the stick.



WARNING! To avoid damage, do not twist the blue housing itself. Hold the stick with 1 hand and use the other hand to rotate the screw. Handtight is enough.

Twisting the stick itself while in the inverter will destroy the cables inside the stick and will void the warranty.

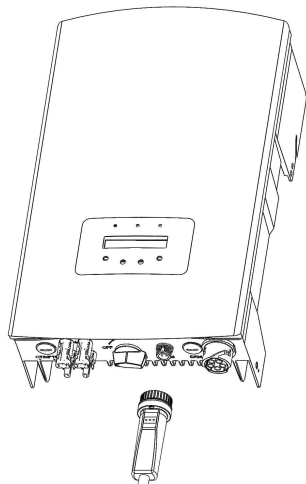

Figure 8. Connection Point & Stick

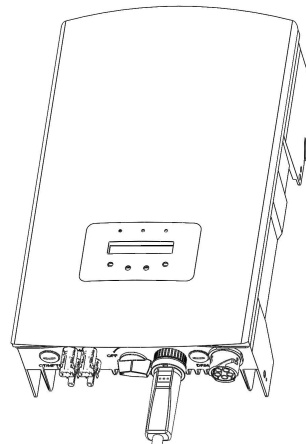

Figure 9. Stick Installation



WARNING! Keep the LAN-stick away from large metal objects and electrical appliances with strong magnetic fields, such as microwave ovens, refrigerators, PV panels and metal walls to ensure communication quality. This connection quality can also be affected by thunderstorms.

3.2 Connection to multiple inverters

The LAN-stick-D can also be used to read out several inverters. To do this, the inverters must be daisy-chained. This is possible with inverters with two RS485 connection points.

1. Connect multiple inverters in parallel with network cables.
2. Connect the LAN-stick-D to the first inverter.
3. Set the addresses for each inverter. For example: if three inverters are connected, the address of the first inverter must be set to "01", the second inverter to "02" and the third inverter to "03".
 - a. On the inverter, press ENTER and then UP/DOWN to navigate to the SETTINGS.
 - b. Select SET ADDRESS
 - c. Use UP/DOWN to select the correct address and press ENTER to save.
 - d. See the inverter manual for more information.

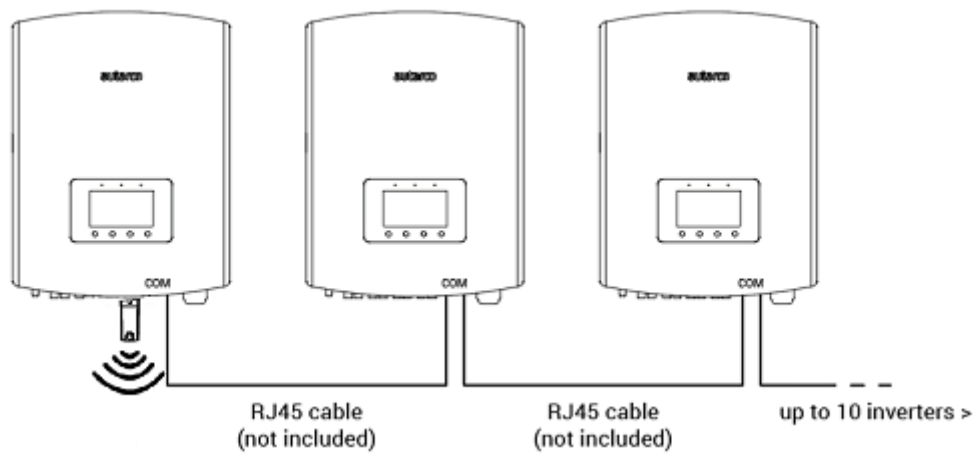

4 Connecting

4.1 Connecting to a wired network

4.1.1 Connecting Ethernet cable

Connect the LAN-STICK-D to your local network using an Ethernet cable. To do this, first unscrew the cap (1) of the stick. Then insert the cable through the cap. For outdoor installations, remove the rubber from the water shield (2), then wrap the rubber around the Ethernet cable and put it back into the water shield. Now the plug of the Ethernet cable can be clicked into the stick (3). All parts can then be screwed back together.

Water protection can be omitted for indoor installations.

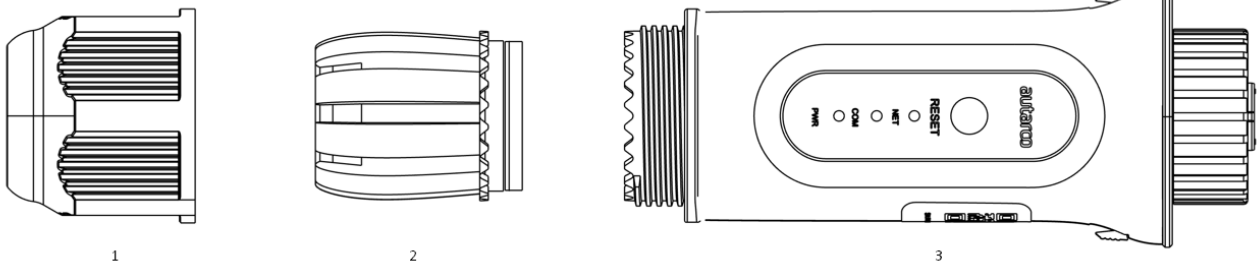

1. Cap
2. Water protection
3. Stick

Then connect the Ethernet cable to the network.

The stick will start working immediately, the green NET light will be on continuously.

4.1.2 Set a static IP address

If you want to set a static IP address, first connect the stick to your laptop or PC. Then navigate in your browser to 10.10.100.254 and use:

Username: **admin**
 Password: **123456789**

1. Go to **Advanced > LAN Settings** and select **Static IP** (image on next page).

The screenshot shows the 'Advanced' settings page for Internet access mode. The 'Dynamic IP' radio button is selected. The 'Save' button is visible at the bottom right. The left sidebar contains 'Status', 'Quick Set', 'Advanced', 'LAN Settings', 'Access point', 'Restart', and 'Reset'. The right sidebar has a 'Help' section with a dropdown arrow and text explaining Dynamic and Static IP.

Status

Quick Set

Advanced

LAN Settings

Access point

Restart

Reset

Internet access mode Dynamic IP Static IP

Save

Help

Dynamic IP:
Automatically obtain an IP address from the router.

Static IP:
Configure a fixed IP address to be used.

The screenshot shows the 'Advanced' settings page for Internet access mode. The 'Static IP' radio button is selected. The 'Subnet mask' is set to '255 . 255 . 255 . 0'. The 'Save' button is visible at the bottom right. The left sidebar contains 'Status', 'Quick Set', 'Advanced', 'LAN Settings', 'Access point', 'Restart', and 'Reset'. The right sidebar has a 'Help' section with a dropdown arrow and text explaining Dynamic and Static IP.

Status

Quick Set

Advanced

LAN Settings

Access point

Restart

Reset

Internet access mode Dynamic IP Static IP

IP address . . .

Subnet mask 255 . 255 . 255 . 0

Gateway . . .

DNS server . . .

Alternate DNS server . . . (optional)

Save

Help

Dynamic IP:
Automatically obtain an IP address from the router.

Static IP:
Configure a fixed IP address to be used.

2. Click **Save**.
3. Then connect the Ethernet cable to the network.

4.2 Connecting to a local WiFi network

4.2.1 Successful installation check

If the stick has been successfully installed on a working inverter, the red PWR light will immediately illuminate. The amber COM light will begin to flash and then remain solid. The green NET light flashes.

If the PWR and/or COM light is blinking or does not lit, go to Section 6. Continue to the next steps only if both, the PWR light and the COM light, are continuously on.

4.2.2 Connecting

You will now establish the connection between the stick and the Autarco server, making use of the existing WiFi network on site.

This is done in two steps:

- A. Connecting to the local WiFi network of the stick.
- B. Provide the stick with access to connect to the router on site via the stick's online interface.

The stick can then use the local internet connection to send monitoring data via your local router to the Autarco server.

Proceed as follows:

1. Find the serial number of the stick. This is on the label of the stick:



5F12092405500310

As an example we will use the LAN-stick serial number 5F12092405500310. Your stick has a different number (you can scan the QR code on the label with the camera function of a smartphone or tablet, which will show the serial number).

- Each LAN-stick creates its own secure wireless network with a network name: Autarco_<stick serial number> (eg "Autarco_5F12092405500310"). Connect to this wireless network with a computer, laptop, tablet or mobile phone and use the password below.

Password: **123456789**

The figure shows an example of this screen in Windows:

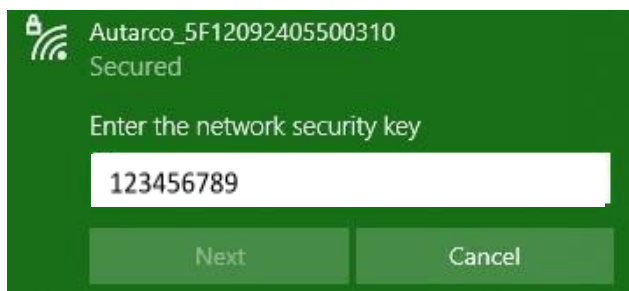

In the case of a LAN-STICK-D it is also possible to connect directly by means of an Ethernet cable (see chapter 4.1).

- After connecting to the stick's network, enter the IP address **10.10.100.254** in the address bar of your web browser:

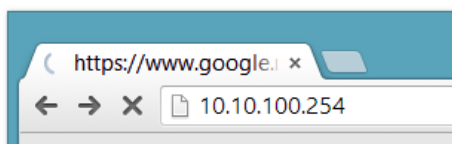

- Access to the LAN-stick's configuration interface is password protected. When prompted for the username and password, use:

Username: **admin**

Password: **123456789**

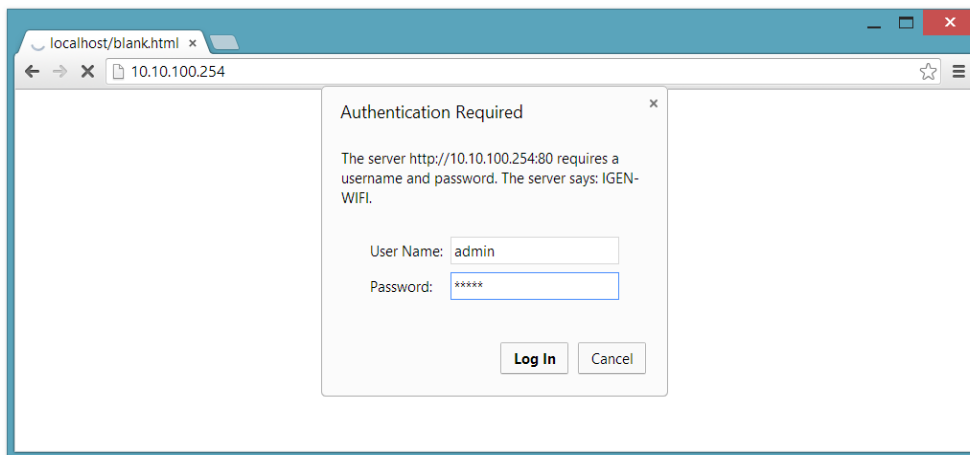

5. Click **Quick Set** from the main menu* on the left.

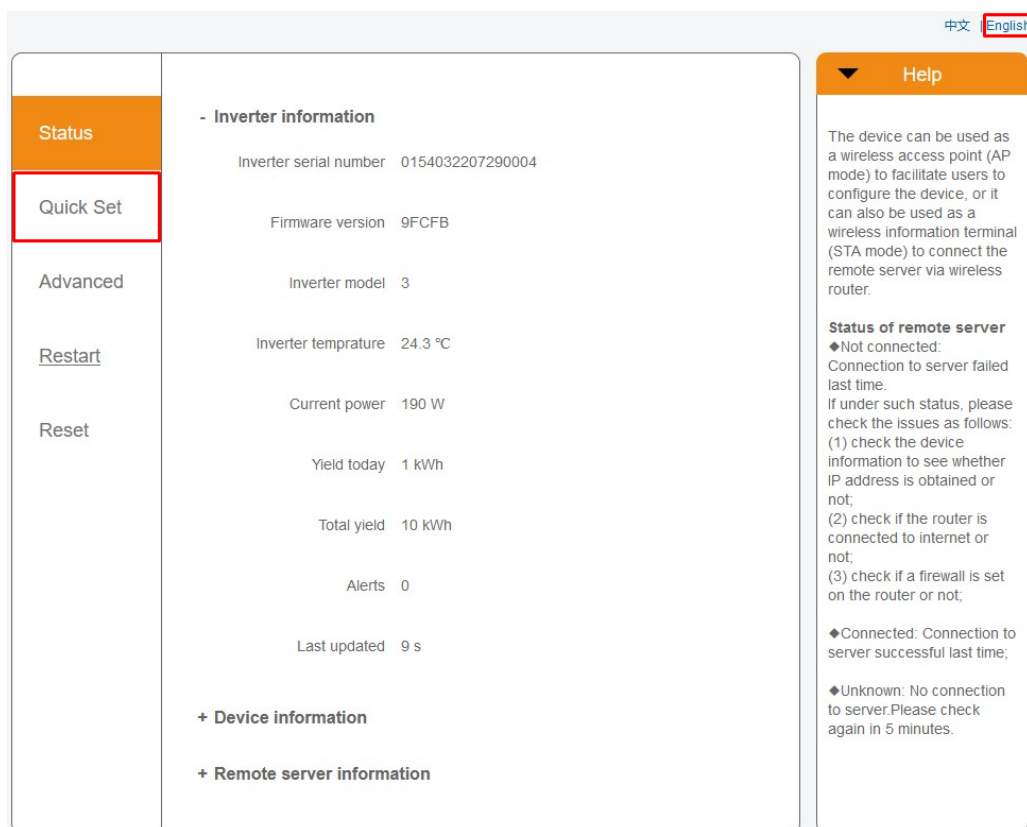

*If the menu is in Chinese, press **English** in the top right corner.

6. Click **Search**.

Network name (SSID) (Note: case sensitive) **Search**

Password (8-64 bytes) (Note: case sensitive)

Obtain an IP address automatically Enable

IP address

Subnet mask

Gateway address

DNS server address

*Note: After clicking Save, the system will restart immediately.

Save

Help

In this page, you can click the "Search" button to automatically search for nearby wireless access point, and connect your device to it by setting the network parameters.

*Note: If you haven't set this kind of device before, please follow the setup wizard.

*Note: After clicking Save, the system will restart immediately.

You need to re-login the configuration interface after restart.

7. A list of nearby WiFi networks will now appear. Find the WiFi signal of your own WiFi router and select it by clicking on the dot. This is the same WiFi network that you connect to on your home devices to use the internet. Click **OK** to continue. If your network is not listed, click **Refresh** and make sure the signal is present at the inverter location. For example, check whether this is the case on your phone. If the strength (RSSI) of the WiFi signal is lower than 30%, no or poor connection* will be established with the inverter.

Please select your current wireless network

Site Survey

SSID	RSSI(%)	Channel
<input checked="" type="radio"/> Your home Wi-Fi network	100	64
<input type="radio"/> Wi-Fi Extender	100	64
<input type="radio"/> Wi-Fi Repeater	100	64
<input type="radio"/> Your neighbors Wi-Fi network	100	64
<input type="radio"/> Ziggo-43643E	100	64
<input type="radio"/> VRV9517UWAC34-A-99	100	64
<input type="radio"/> Timmie en Lauw wifi	80	96

*Note: When RSSI of the selected WiFi network is lower than 15%, the connection may be unstable, please select other available network or shorten the distance between the device and router.

OK **Refresh**

Help

Please refresh repeatedly if there is no desirable wireless access point available.

*Make sure the inverter is installed within range of your local WiFi network. If necessary, move your router or use a WiFi extender or an extra Access Point.

8. Enter your local WiFi network password. You can click on the eye icon to make the password visible. This is the same password that you use on other devices to connect to the Internet: it may be on the back of your router.

The screenshot shows the 'Quick Set' configuration page. The 'Password (8-64 bytes)' field is highlighted with a red box. The 'Network name (SSID)' is 'Your home Wi-Fi network'. The 'Obtain an IP address automatically' option is set to 'Enable'. The 'Save' button is at the bottom right. The 'Help' sidebar on the right contains the following text:

In this page, you can click the "Search" button to automatically search for nearby wireless access point, and connect your device to it by setting the network parameters.

*Note: If you haven't set this kind of device before, please follow the setup wizard.

*Note: After clicking Save, the system will restart immediately.

You need to re-login the configuration interface after restart.



WARNING! Passwords are case sensitive. If you're using an iPad, iPhone, or other mobile device, make sure the first character of the password isn't automatically capitalized.

9. A) If your local WiFi router is set up to assign IP addresses automatically, click **Save** to complete the installation. This is the most commonly used method. Proceed to step 10.
- B) If you have a corporate network, disable the "Obtain an IP address automatically" option by **Disable** selecting, enter the next four fields and click **Save** to save the settings (see image on next page).

The screenshot shows a web configuration interface for a LAN-stick. On the left is a navigation menu with options: Status, Quick Set (highlighted in orange), Advanced, Restart, and Reset. The main content area is titled 'Quick Set' and contains the following fields and controls:

- Network name (SSID) (Note: case sensitive): A text input field containing 'Your home Wi-Fi network' and a 'Search' button.
- Password (8-64 bytes) (Note: case sensitive): A password input field with a toggle for visibility.
- Obtain an IP address automatically: A checkbox labeled 'Enable' which is checked and highlighted with a red box.
- IP address: An empty text input field.
- Subnet mask: An empty text input field.
- Gateway address: An empty text input field.
- DNS server address: An empty text input field.
- A note at the bottom: '*Note: After clicking Save, the system will restart immediately.'
- A 'Save' button at the bottom right.

On the right side, there is a 'Help' section with the following text:

In this page, you can click the "Search" button to automatically search for nearby wireless access point, and connect your device to it by setting the network parameters.

*Note: If you haven't set this kind of device before, please follow the setup wizard.

*Note: After clicking Save, the system will restart immediately.

You need to re-login the configuration interface after restart.

At the bottom of the page, it says 'Web Ver:1.0.0'.

10. After clicking **Save**, the LAN-stick will restart and try to connect to your WiFi network. If this is successful, the stick's own WiFi signal will be disabled so that no one can log in to it. All three lights will now be continuously lighting.

The installation is complete when all three LEDs are continuously on. The LEDs will blink occasionally when the stick is transmitting data. The inverter is now connected to your local WiFi network and transmits its monitoring data to our Autarco server.

If the green light is not solid, try the following:

- Reconnect to the stick's WiFi network/AP (Autarco_<serial number>).
- If it doesn't show up, press and hold the reset button on the stick for **15 seconds** until the COM light (orange) and NET light (green) **go off**. This will reset the stick and will enable AP mode again.
- Repeat steps 1 until 8.

Note: Always make sure that **your router's WiFi channel** is set to **1 to 11** (not 12 or 13).

4.3 New stick's IP address after installation

After successful connection, the stick's IP address will change. To find out this IP address, log in to the router to find the new IP address in the list of connected devices. Some routers require you to switch off and on to refresh the list of connected devices.

5 Access MyAutarco monitoring platform

5.1 Access MyAutarco monitoring platform (installer)

Once the Autarco server successfully received monitoring messages, you need to link the data to the associated system (digital twin) in Helios and generate the MyAutarco login for the end user. End users should contact their installer for this.

By registering and linking the serial numbers of the installed products does the software of Autarco knows to which system, inverter and string the received monitoring data must be linked. Then we start displaying the data in MyAutarco for both the dealer and the end user.



NOTE TO THE INSTALLER

Before registering the system with Autarco, you must confirm the following from your customer regarding the creation of their monitoring and kWh warranty certificates:

- First name
- Last name
- Email address
- Phone number
- Installation address

You can access monitoring data on MyAutarco, via the website <http://my.autarco.com> or via the MyAutarco app.

5.2 Access MyAutarco monitoring platform (user)

You will receive your login details by email after the installer has registered your system with Autarco. You can access monitoring data on MyAutarco, via the website <http://my.autarco.com> or via the MyAutarco app.

6 Resetting the stick

The reset button on the stick has two functions:

1. Force a message

Briefly press the reset button once to force a message that is immediately sent to the Autarco server.

2. Perform reset

Press and hold the reset button for 15 seconds to reset the stick to factory settings. The COM light (orange) and NET light (green) turn off temporarily. This reset will then re-enable the stick's WiFi Access Point (stick's WiFi network) so that you can redo the settings in chapter 3.

Warning! **DO NOT** remove the LAN-stick from the inverter. This is not necessary for reset.

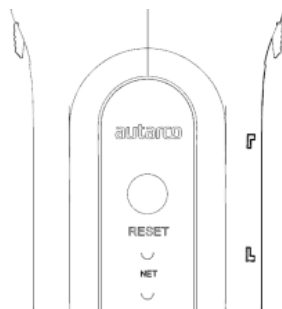

Figure 10. Reset button on stick

7 Troubleshooting

7.1 The stick has no power (red 'PWR' light is off)

If the inverter is powered on, the stick is installed correctly and the address setting in the inverter is <01>, but the red led does not turn on, then the stick may be defective and/or the internal cables are broken.

Try installing another stick, making sure that you **only use the black ring** to tighten. **NOT the blue housing** of the stick. Hold the stick with one hand and turn the black ring with the other hand.

7.2 Red 'PWR' light on, orange 'COM' light is off

The LAN-stick is powered (on), but cannot receive data from at least one of the connected inverters.

1. Briefly press the button on the back of the stick once (this will attempt to force a message).
2. Check the address setting* of the inverter.

Address setting in inverter:

If the LAN-stick only reads out one inverter, the address setting of the inverter must always be <01>. If the LAN-stick reads more than one inverter, the first inverter must be set to <01>. The other inverters must be numbered consecutively.

To check the inverter address, use the up and down buttons on the inverter, go to **Settings > Set Address > select correct number > Enter**.

*This address is used to identify inverters when multiple inverters are read by one device.

7.3 Signal quality

The most common reason why the LAN-stick cannot establish a good connection to the remote Autarco server is a weak WiFi connection to the local router. Check whether the stick has a sufficient signal:

- Check the signal quality in chapter 4. A **signal quality of 30% or more is sufficient**.
- If the signal quality is less than 30%, please move the router closer to the inverter with stick. If this is not possible, install one or more WiFi repeaters (also called WiFi extenders) between the local router and the inverter.
- Make sure that the network name (SSID) of the WiFi repeater is different from the network name of the router, for example by adding "-extended". By doing so, you ensure that the LAN-stick connects to the repeater and not directly to the router.
- Follow the instructions in chapter 4 after installing the WiFi repeater.

7.4 Local router settings

If the signal quality is insufficient, or if you cannot connect to the local WiFi network at all, check the settings below on the local router to ensure and optimize WiFi connectivity.

- Log in to the router by browsing the router's IP address using a computer, laptop, tablet, or mobile phone that is connected to the router's wireless network.

If you don't know the router's IP address, see the following web page:

<http://www.computerworld.com/article/2474776/network-security-find-the-ip-address-of-your-home-router.html>



WARNING! Autarco does not and cannot know the router username and password. Default usernames and passwords depend on the router brand and series.

Try changing the following settings on the router:

- Many routers are configured to use multiple protocols from the WiFi 802.11 family, eg b/g/n. Configure the router to use only 802.11n or only 802.11g.

On some routers, the alternatives are 802.11b/g/n and 802.11b/g (so-called 'mixed modes'). In these cases, select the last option: 802.11b/g.

You want to have as few protocols as possible 'mixed'.

- Make sure the wireless channel is between **1 and 11** .
- Set WiFi encryption to only one encryption type, such as WPA2-Personal or WPA2-PSK. Disable mixed or multiple encryption types.
- The stick can handle all characters, such as **! @ # \$ % & * () _ + - = [] \ { } | ; : ' " , . / < > ?**, but some characters are not allowed on all router/stick combinations. In case of problems, use only alphanumeric (letters and/or numbers) characters, such as **az, AZ, A9** and **09** for the network name (SSID) and WiFi password.
- The router must dynamically assign IP addresses to connected devices. This is called DHCP (Dynamic Host Configuration Protocol). Please enable **DHCP** on the router.
- Some routers may require a region setting to work correctly. If so, choose a region setting.



WARNING! Changing some of these router settings may disconnect other connected devices such as computers, laptops, tablets or mobile phones. Please reconnect them with the new settings.